

25mm DSP PowerSlide x 0

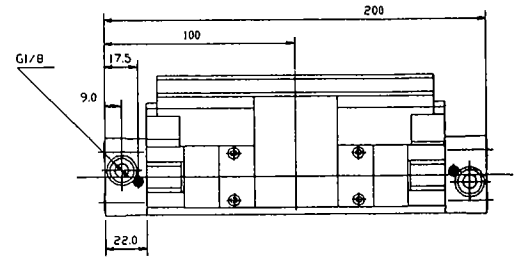

25/35 DSP Powerslide x 0

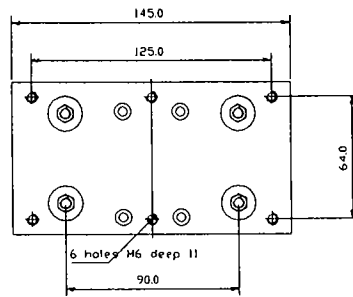
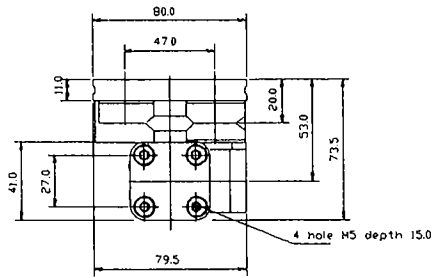
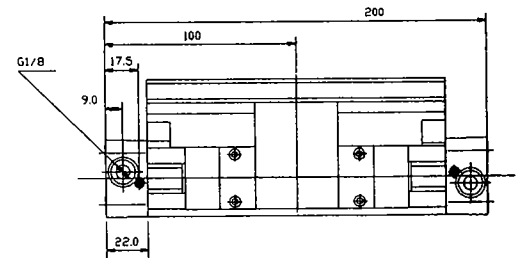
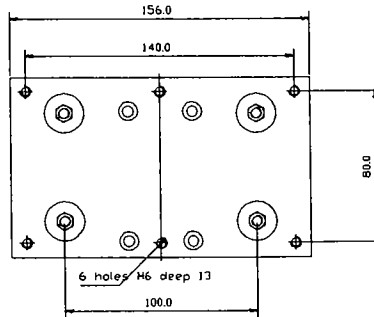
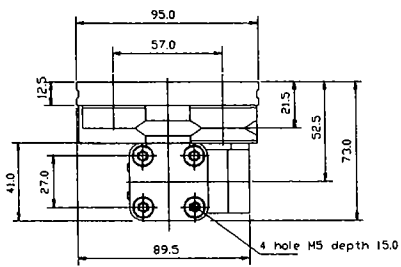

file:25 Slideline x 0

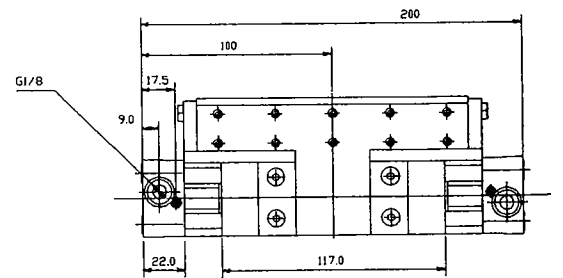
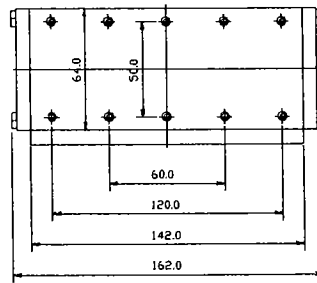
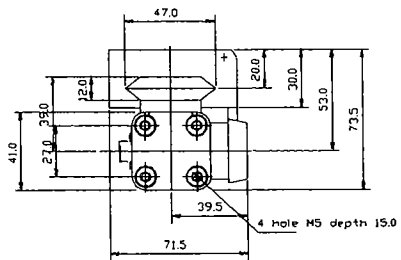

25-2021/50X0

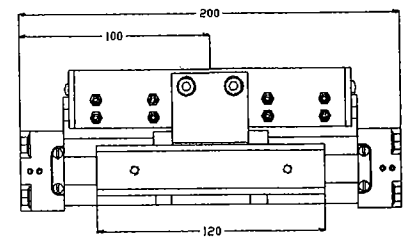
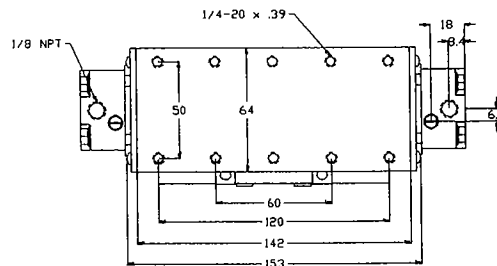
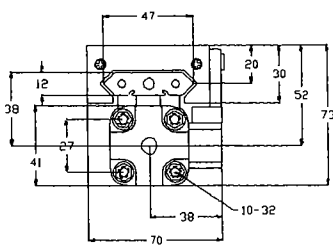

file: 25 Dimensional Comparison.dwg

32mm Dimensional Cylinder Comparison

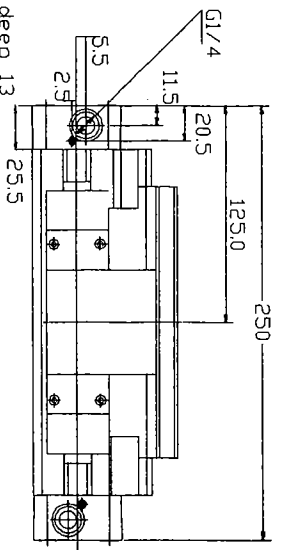
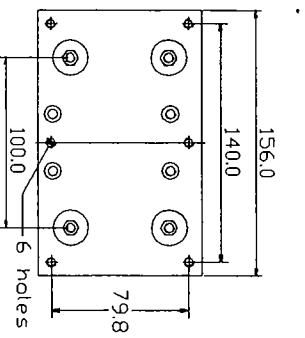
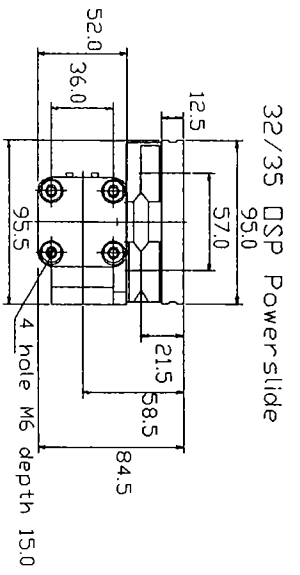

32/44 DSP Powerslide

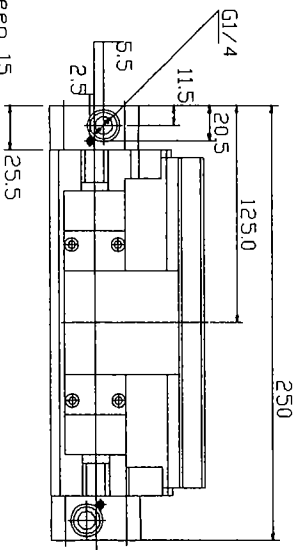
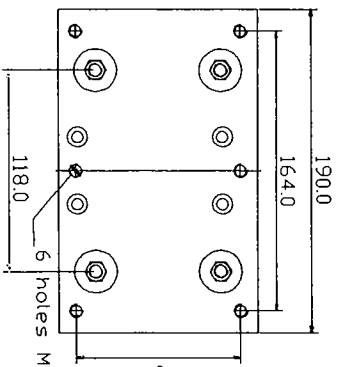
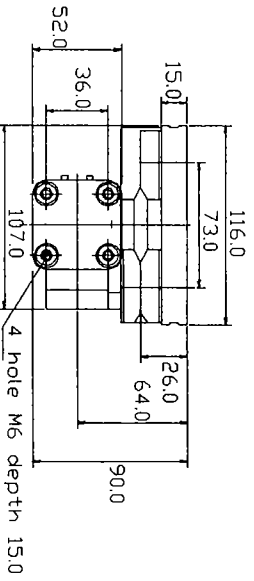

32 Slideline

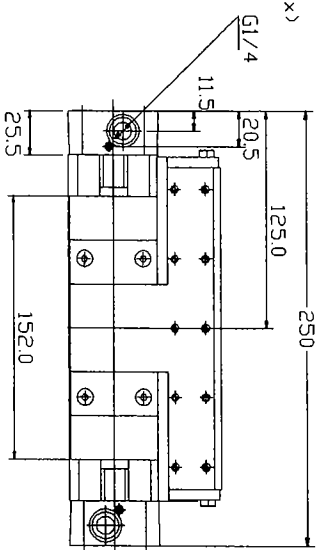
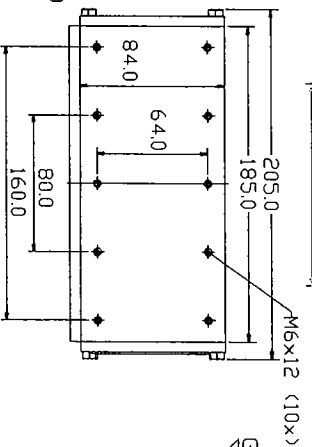
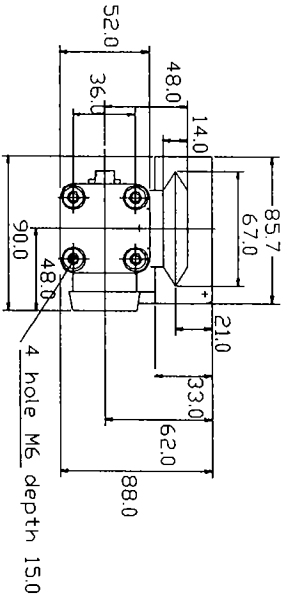

32-2020/50X0

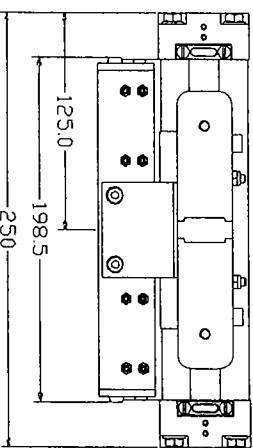
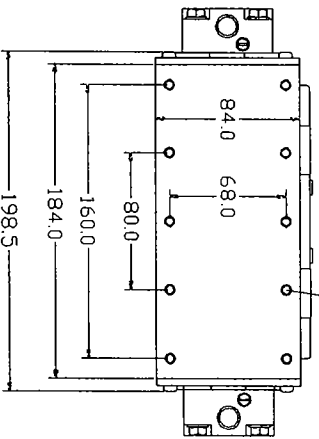
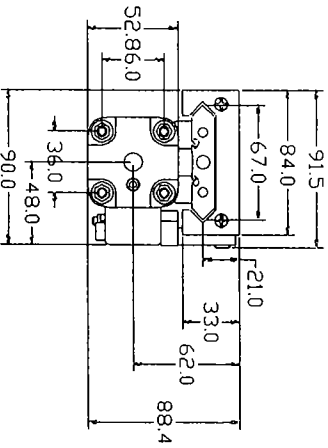

40mm bore guided cylinder comparisons

40/44 DSP Powerslide.

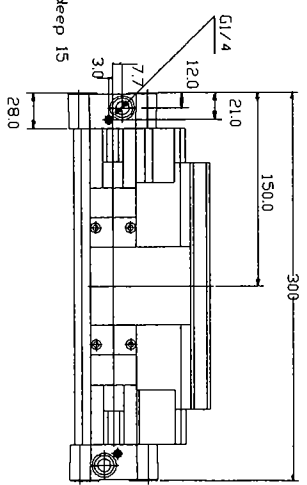
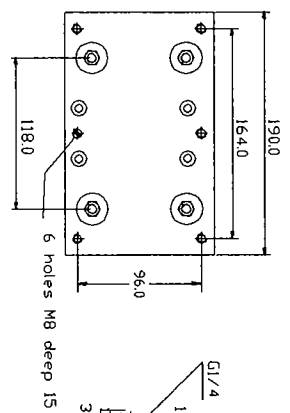
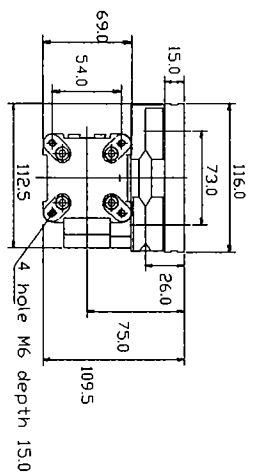

40/60 DSP Powerslide.

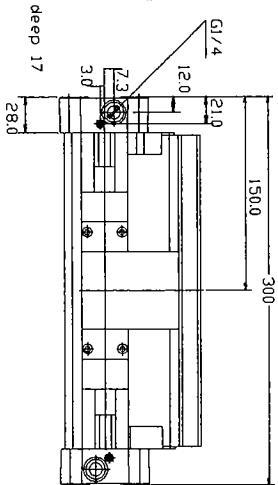
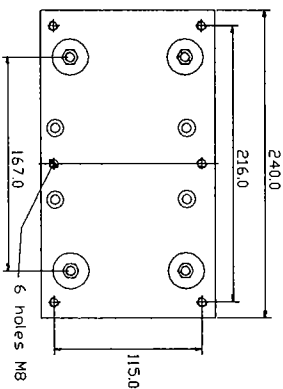
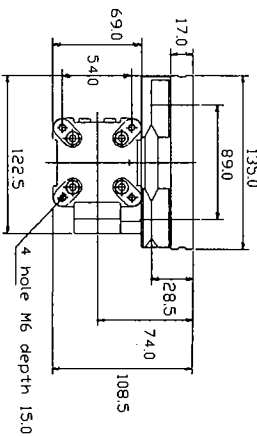

file: 40 Slideline

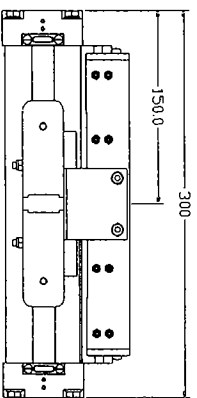
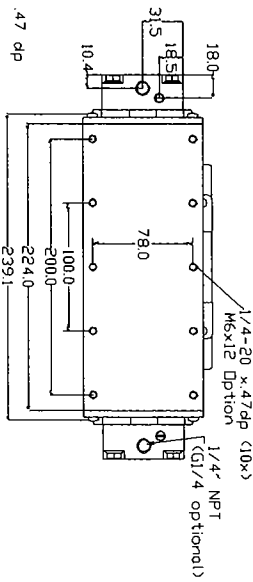
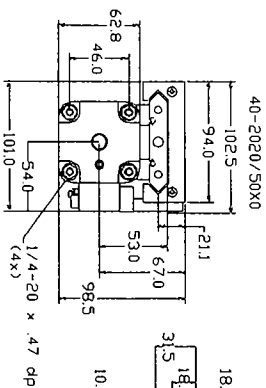
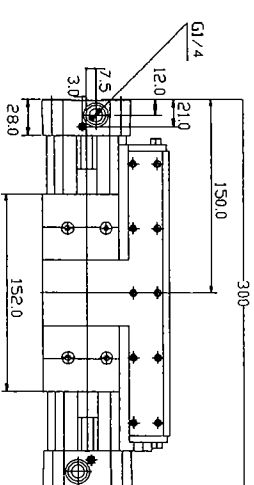
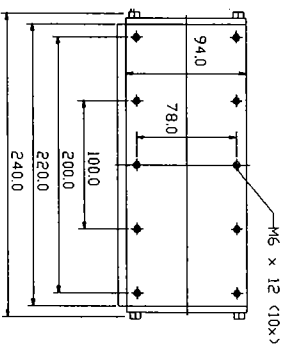
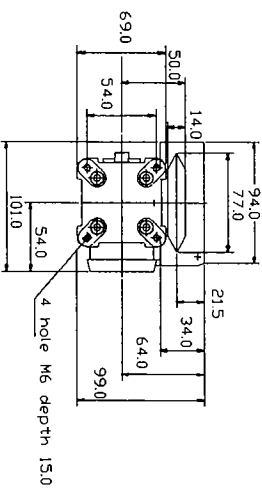

50_76 DSP Powerslide x 0

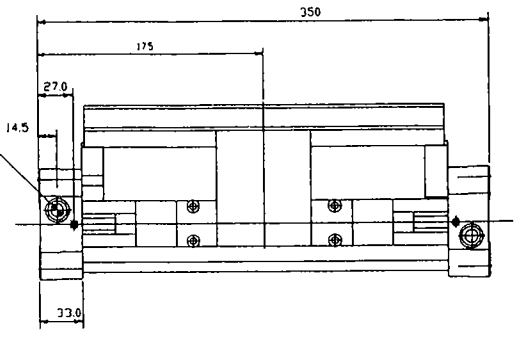
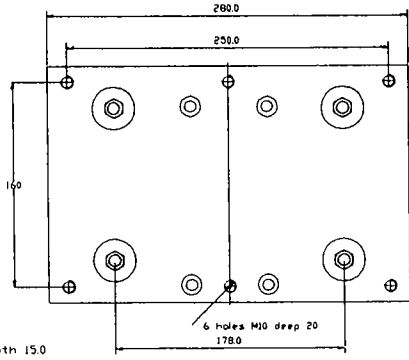
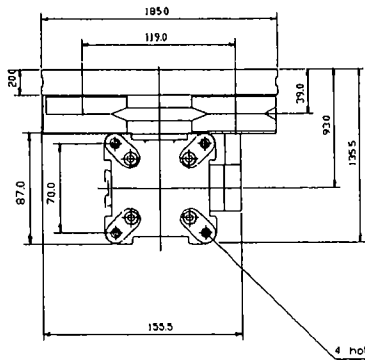

file: 50_60 DSP Powerslide x 0

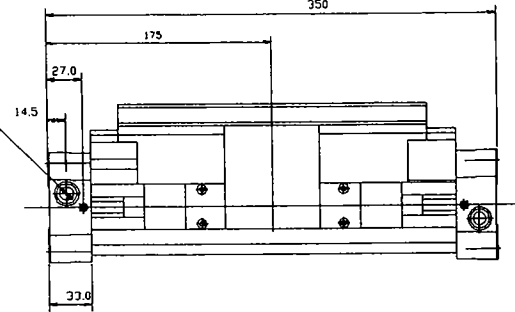
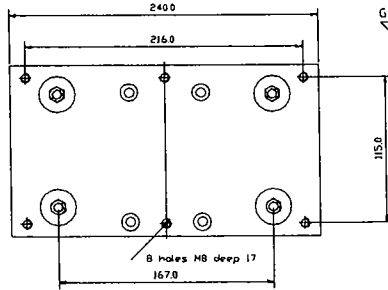
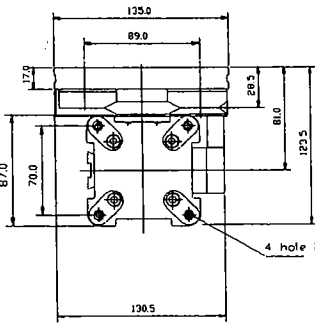

50 Slideline x 0

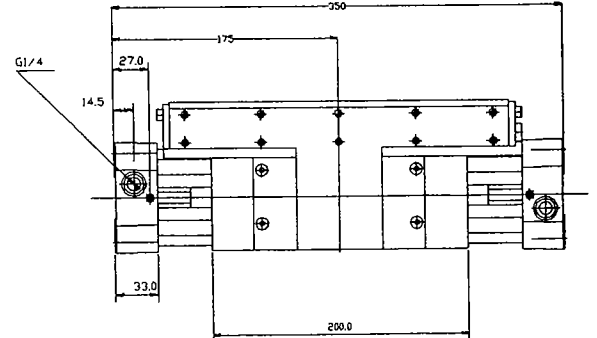
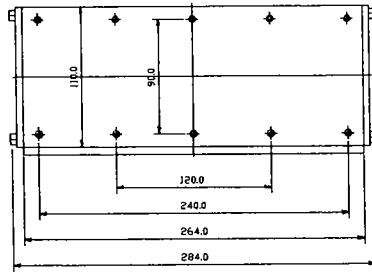
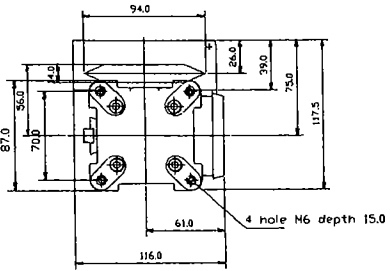

50-2021/50x0

