

400544 1 PCS.

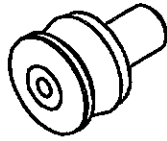

401018 1 PCS.

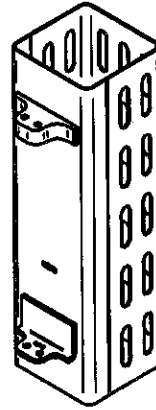

401760 10 PCS.

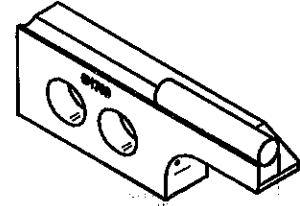

401705 1 PCS.

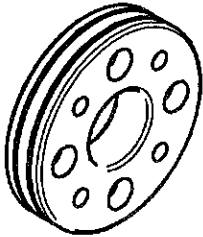

G1783 2 PCS.

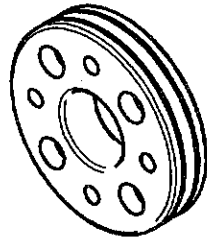

Z1736
~~Y1737~~ 2 PCS.

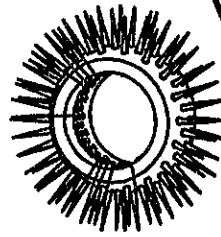

401850 2 PCS.

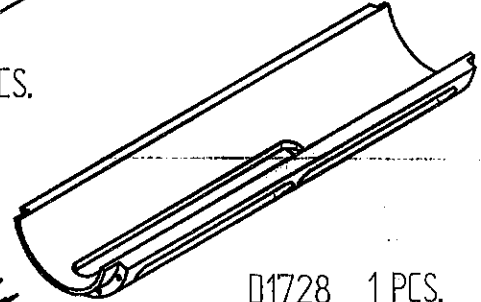

D1728 1 PCS.

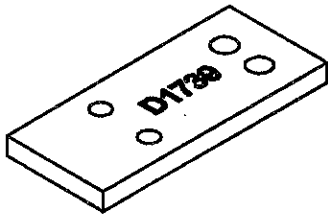

D1739 2 PCS.

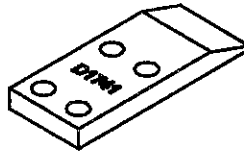

D1741 4 PCS.

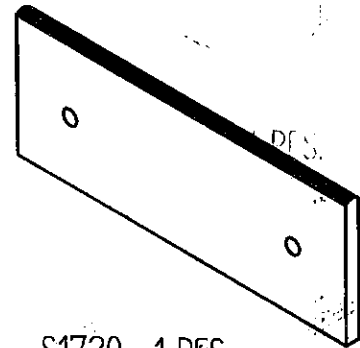

S1720 1 PCS.

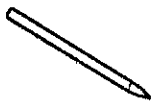

P1137 5 PCS.

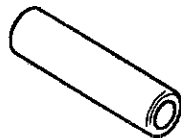

3935 2 PCS.

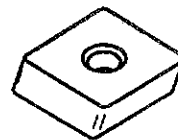

3936 2 PCS.

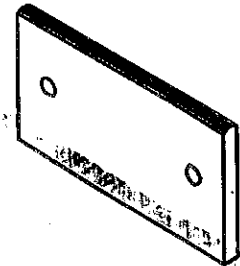

S1735 1 PCS.

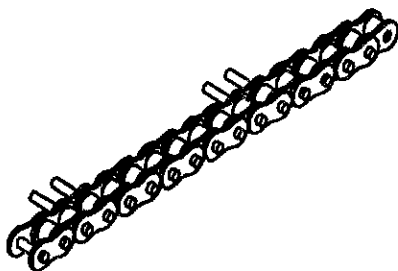

CONVEYOR CHAIN 1 Mt.

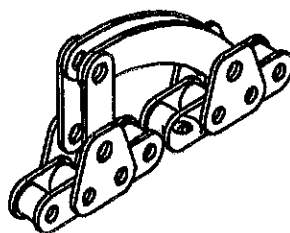

TRANSFER CHAIN 1 SET



TIMEING BELTS 1 SET